

ROTATOR HR16-02

Specially designed for the Harvester heads

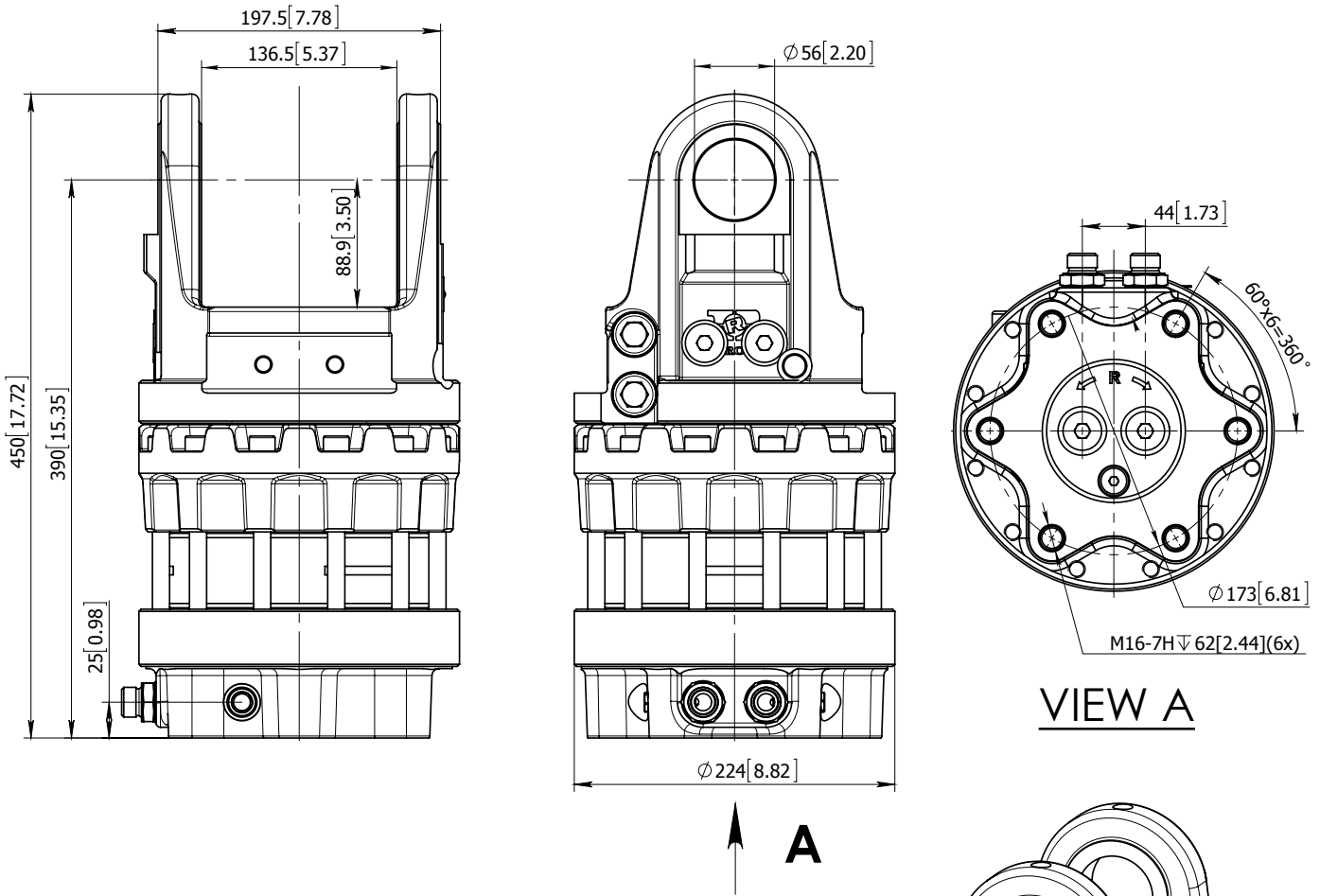

Technical data

Rotation	Unlimited
Max axial load static, kN (lbf)	+160 (35976) -100 (22485)
Max axial load dynamic, kN (lbf)	+80 (17988) -50 (11242)
Torque at 25MPa (3625psi), Nm (lb ft)	3500 (2581)
Rec oilflow, l/min (US gallon)	40 (10.6)
Weight, kg (lb)	76 (169)

Max working pressure:

Rotator ←R→ Max 25 MPa (3625 psi)*

* Relief valves fitted

Connection:

G 1/2

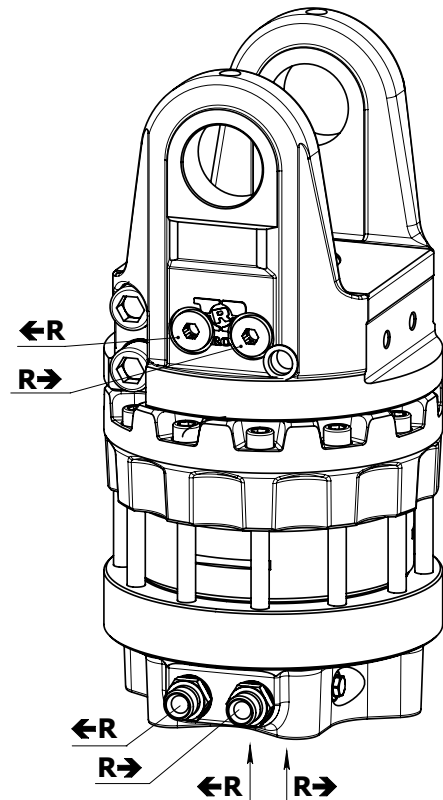

17.02.2016. Sheet 1 of 3